

R-6B オス×メスユニオン(面シール)

R-6C オス×メスユニオン(PTFEガスケット)

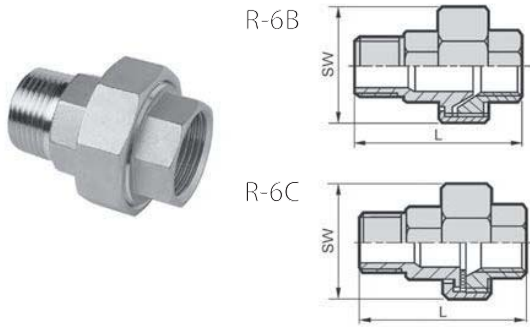

型式:R-6B 単位:mm

SIZE	L	SW
1/8"	40.0	25.0
1/4"	50.0	30.0
3/8"	50.0	35.0
1/2"	58.0	42.0
3/4"	67.0	47.0
1"	68.3	53.0
1-1/4"	83.0	71.0
1-1/2"	86.3	78.0
2"	94.0	92.0

型式:R-6C 単位:mm

SIZE	L	SW
1/8"	41.0	25.0
1/4"	50.0	30.0
3/8"	50.0	35.0
1/2"	58.0	42.0
3/4"	67.0	47.0
1"	69.0	53.0
1-1/4"	83.0	71.0
1-1/2"	87.0	78.0
2"	95.0	92.0

R-7A 径違い六角ニップル



型式:R-7A 単位:mm

SIZE	L	SW
1/4"×1/8"	34.0	18.0
3/8"×1/8"	35.0	21.0
3/8"×1/4"	34.0	21.0
1/2"×1/8"	34.0	26.0
1/2"×1/4"	34.0	26.0
1/2"×3/8"	41.0	26.0
3/4"×1/8"	37.0	30.0
3/4"×1/4"	37.0	30.0
3/4"×3/8"	37.0	30.0
3/4"×1/2"	45.0	30.0
1"×1/8"	39.0	35.0
1"×1/4"	39.0	35.0
1"×3/8"	40.0	35.0
1"×1/2"	43.2	35.0
1"×3/4"	50.0	37.0
1-1/4"×1/4"	45.0	46.0
1-1/4"×3/8"	46.0	46.0
1-1/4"×1/2"	48.0	46.0
1-1/4"×3/4"	52.0	46.0
1-1/4"×1"	54.0	46.0
1-1/2"×3/8"	48.0	50.0
1-1/2"×1/2"	49.0	50.0
1-1/2"×3/4"	53.0	50.0

型式:R-7A 単位:mm

SIZE	L	SW
1-1/2"×1"	53.0	50.0
1-1/2"×1-1/4"	59.0	50.0
2"×1/2"	52.0	63.0
2"×3/4"	56.0	63.0
2"×1"	57.0	63.0
2"×1-1/4"	58.0	63.0
2"×1-1/2"	65.4	64.0

R-72 六角ニップル

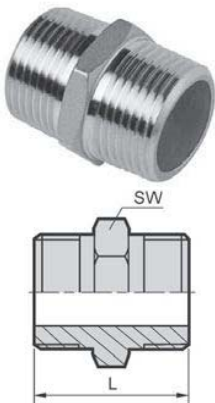

型式:R-72(NPT/PT) 単位:mm

SIZE	L	SW
1/8"	29.0	12.0
1/4"	32.5	17.0
3/8"	36.0	20.0
1/2"	42.5	26.0
3/4"	46.0	32.0
1"	51.5	38.0
1-1/4"	56.0	46.0
1-1/2"	60.0	52.5
2"	65.0	62.0

R-7B 両長ニップル

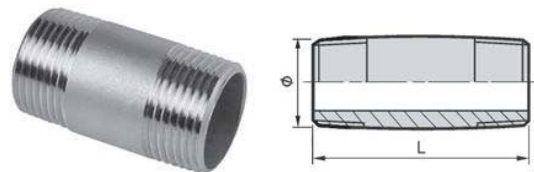

型式:R-7B 単位:mm

SIZE	φ	L
1/8"	10.4	50 / 75 / 100 / 125 / 150 / 200
1/4"	13.8	50 / 75 / 100 / 125 / 150 / 200
3/8"	17.3	50 / 75 / 100 / 125 / 150 / 200
1/2"	21.7	50 / 75 / 100 / 125 / 150 / 200
3/4"	27.1	50 / 75 / 100 / 125 / 150 / 200
1"	34.0	50 / 75 / 100 / 125 / 150 / 200
1-1/4"	42.8	75 / 100 / 125 / 150 / 200
1-1/2"	48.5	75 / 100 / 125 / 150 / 200
2"	60.5	75 / 100 / 125 / 150 / 200

R-7C 片ニップル

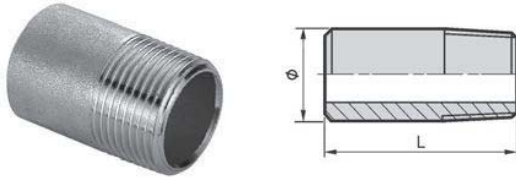

型式:R-7C 単位:mm

SIZE	φ	L
1/8"	10.4	30.0
1/4"	13.8	30.0
3/8"	17.3	30.0
1/2"	21.7	35.0
3/4"	27.1	40.0
1"	34.0	40.0
1-1/4"	42.8	50.0
1-1/2"	48.5	50.0
2"	60.5	50.0

R-7G ニップル



型式:R-7G 単位:mm

SIZE	φ	L
1/8"	10.4	24.0
1/4"	13.8	26.0
3/8"	17.3	28.0
1/2"	21.7	34.0
3/4"	27.1	38.0
1"	34.0	42.0
1-1/4"	42.8	50.0
1-1/2"	48.5	50.0
2"	60.5	58.0

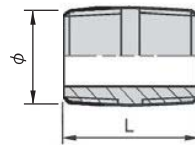

R-7D ホースニップル

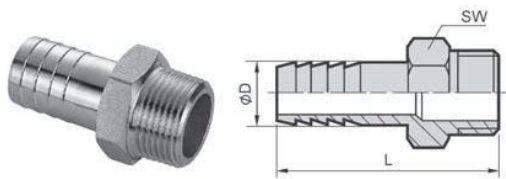

型式:R-7D 単位:mm

SIZE	φD	L	SW
1/8"	4.50	45.0	12.5
1/4"	6.35	47.0	16.5
3/8"	9.50	55.0	20.0
1/2"	12.70	64.0	23.5
3/4"	19.05	68.0	31.0
1"	25.40	71.0	38.5
1-1/4"	31.80	80.0	46.0
1-1/2"	38.10	95.0	52.0
2"	50.80	105.0	62.0

R-8 六角プラグ(テーパードネジ)

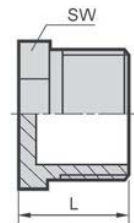

型式:R-8 単位:mm

SIZE	L	SW
1/8"	17.0	12.0
1/4"	17.5	16.0
3/8"	18.0	20.0
1/2"	25.0	24.0
3/4"	26.0	30.0
1"	29.0	38.0
1-1/4"	35.0	46.0
1-1/2"	38.0	52.0
2"	39.0	65.0

R-7F 片長ニップル

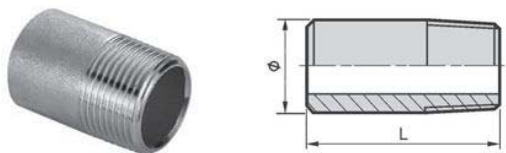

型式:R-7F 単位:mm

SIZE	φ	L
1/8"	10.4	50 / 75 / 100 / 125 / 150 / 200
1/4"	13.8	50 / 75 / 100 / 125 / 150 / 200
3/8"	17.3	50 / 75 / 100 / 125 / 150 / 200
1/2"	21.7	50 / 75 / 100 / 125 / 150 / 200
3/4"	27.1	50 / 75 / 100 / 125 / 150 / 200
1"	34.0	50 / 75 / 100 / 125 / 150 / 200
1-1/4"	42.8	75 / 100 / 125 / 150 / 200
1-1/2"	48.5	75 / 100 / 125 / 150 / 200
2"	60.5	75 / 100 / 125 / 150 / 200

R-8B 四角プラグ

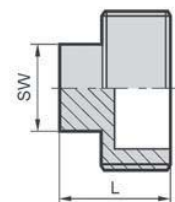

型式:R-8B 単位:mm

SIZE	L	SW
1/8"	19.0	6×6
1/4"	20.0	9×9
3/8"	22.0	11×11
1/2"	25.0	13×13
3/4"	27.0	16×16
1"	32.0	20×20
1-1/4"	35.0	24×24
1-1/2"	36.0	25×25
2"	38.0	32×32